

Ch.6: Analysis of Laminated Composites

The transverse properties of unidirectional composites are unsatisfactory for most practical applications.

The goal of this chapter is to analyse the stacking sequence in order to achieve adequate anisotropic properties.

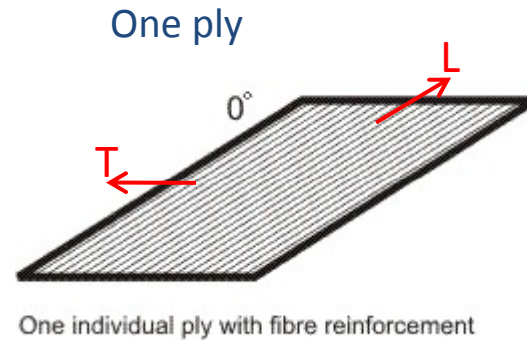

Stacking of plies with different angles for *tailoring* (stiffness, thermal stability)

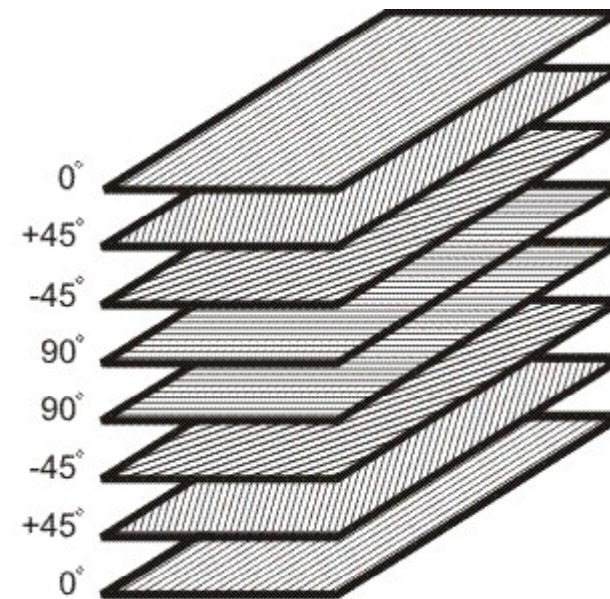

Stacking of plies into a composite laminate with different angles of the fibre reinforcement

Stress and strain variation in a laminate

Kirchhoff plate theory:

A line ABCD originally straight and normal to the mid-plane remains straight in the deformed state: A'B'C'D' (no shear deformation)

Displacements of the midplane: u_0, v_0, w_0

Slope of the laminate in the (x,z) plane: $\alpha = \frac{\partial w_0}{\partial x}$

Displacements at a point at a distance z from the midplane: $u = u_0 - z\alpha$

$$\begin{aligned} u &= u_0 - z \frac{\partial w_0}{\partial x} \\ v &= v_0 - z \frac{\partial w_0}{\partial y} \\ w &= w_0 \end{aligned}$$



Figure 6.1. Bending of line element in $x-z$ plane.

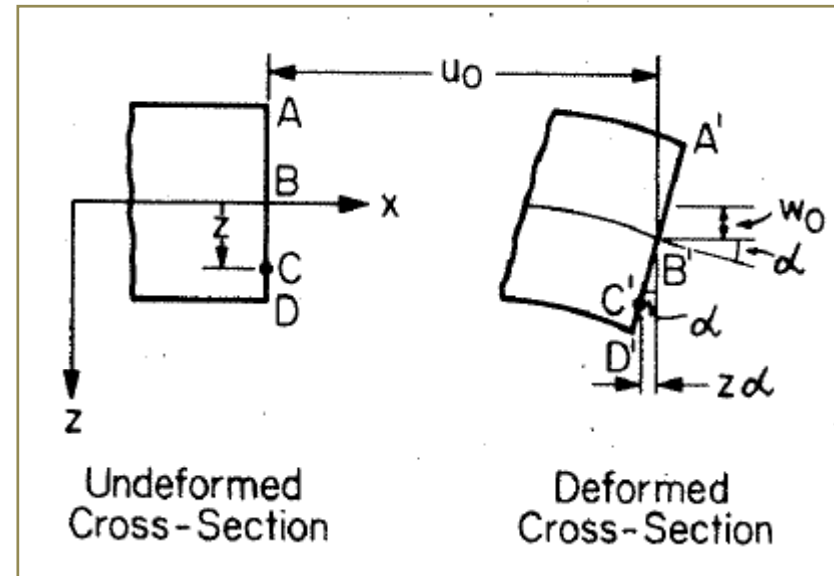

$$\begin{aligned} \epsilon_x &= \frac{\partial u}{\partial x} = \frac{\partial u_0}{\partial x} - z \frac{\partial^2 w_0}{\partial x^2} \\ \epsilon_y &= \frac{\partial v}{\partial y} = \frac{\partial v_0}{\partial y} - z \frac{\partial^2 w_0}{\partial y^2} \\ \gamma_{xy} &= \frac{\partial u}{\partial y} + \frac{\partial v}{\partial x} = \frac{\partial u_0}{\partial y} + \frac{\partial v_0}{\partial x} - 2z \frac{\partial^2 w_0}{\partial x \partial y} \end{aligned}$$

$$\begin{Bmatrix} \epsilon_x \\ \epsilon_y \\ \gamma_{xy} \end{Bmatrix} = \begin{Bmatrix} \epsilon_x^0 \\ \epsilon_y^0 \\ \gamma_{xy}^0 \end{Bmatrix} + z \begin{Bmatrix} k_x \\ k_y \\ k_{xy} \end{Bmatrix}$$

Mid-plane strains
(membrane)

Plate curvatures

$$\begin{Bmatrix} k_x \\ k_y \\ k_{xy} \end{Bmatrix} = - \begin{Bmatrix} \frac{\partial^2 w_0}{\partial x^2} \\ \frac{\partial^2 w_0}{\partial y^2} \\ 2 \frac{\partial^2 w_0}{\partial x \partial y} \end{Bmatrix}$$

The strain varies linearly across the thickness
However, the stiffness properties are discontinuous from one layer to the next

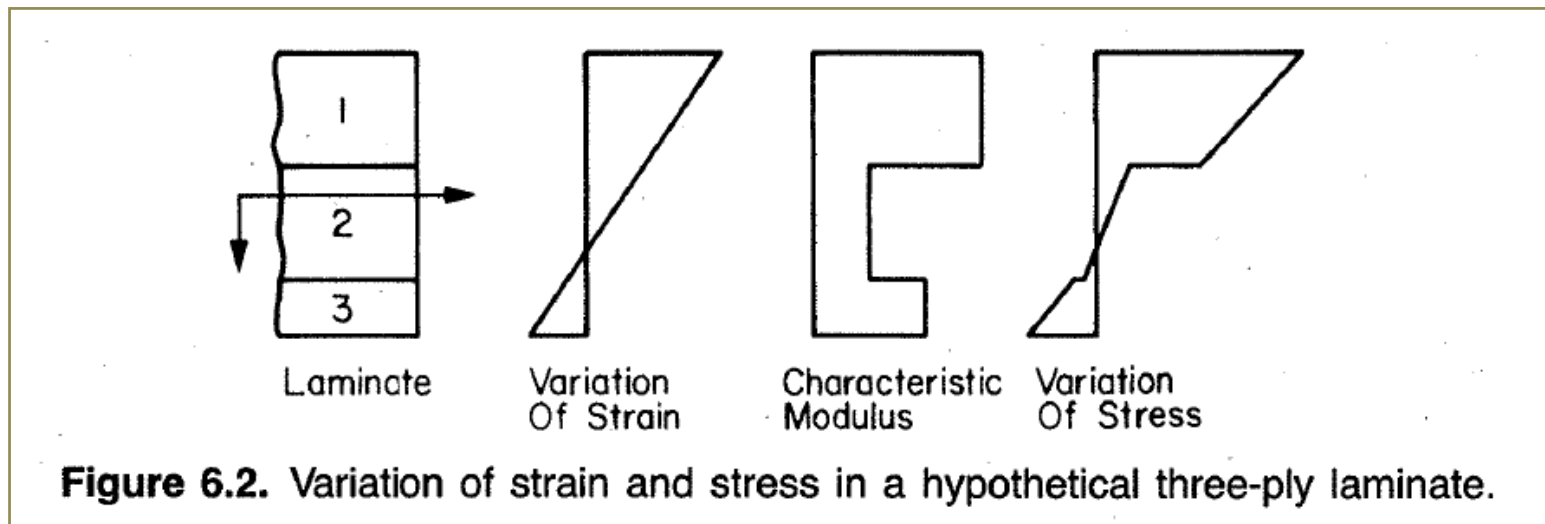

Every layer is characterized by its stiffness matrix

$$\begin{Bmatrix} \sigma_x \\ \sigma_y \\ \tau_{xy} \end{Bmatrix}_k = \begin{bmatrix} \bar{Q}_{11} & \bar{Q}_{12} & \bar{Q}_{16} \\ \bar{Q}_{12} & \bar{Q}_{22} & \bar{Q}_{26} \\ \bar{Q}_{16} & \bar{Q}_{26} & \bar{Q}_{66} \end{bmatrix}_k \begin{Bmatrix} \epsilon_x \\ \epsilon_y \\ \gamma_{xy} \end{Bmatrix}_k$$

$$\begin{Bmatrix} \sigma_x \\ \sigma_y \\ \tau_{xy} \end{Bmatrix}_k = \begin{bmatrix} \bar{Q}_{11} & \bar{Q}_{12} & \bar{Q}_{16} \\ \bar{Q}_{12} & \bar{Q}_{22} & \bar{Q}_{26} \\ \bar{Q}_{16} & \bar{Q}_{26} & \bar{Q}_{66} \end{bmatrix}_k \begin{Bmatrix} \epsilon_x^0 \\ \epsilon_y^0 \\ \gamma_{xy}^0 \end{Bmatrix} + z \begin{bmatrix} \bar{Q}_{11} & \bar{Q}_{12} & \bar{Q}_{16} \\ \bar{Q}_{12} & \bar{Q}_{22} & \bar{Q}_{26} \\ \bar{Q}_{16} & \bar{Q}_{26} & \bar{Q}_{66} \end{bmatrix}_k \begin{Bmatrix} k_x \\ k_y \\ k_{xy} \end{Bmatrix}$$

Resultant forces and moments

$$N_x = \int_{-h/2}^{h/2} \sigma_x dz$$

$$M_x = \int_{-h/2}^{h/2} \sigma_x z dz$$

$$N_y = \int_{-h/2}^{h/2} \sigma_y dz$$

$$M_y = \int_{-h/2}^{h/2} \sigma_y z dz$$

$$N_{xy} = \int_{-h/2}^{h/2} \tau_{xy} dz$$

$$M_{xy} = \int_{-h/2}^{h/2} \tau_{xy} z dz$$

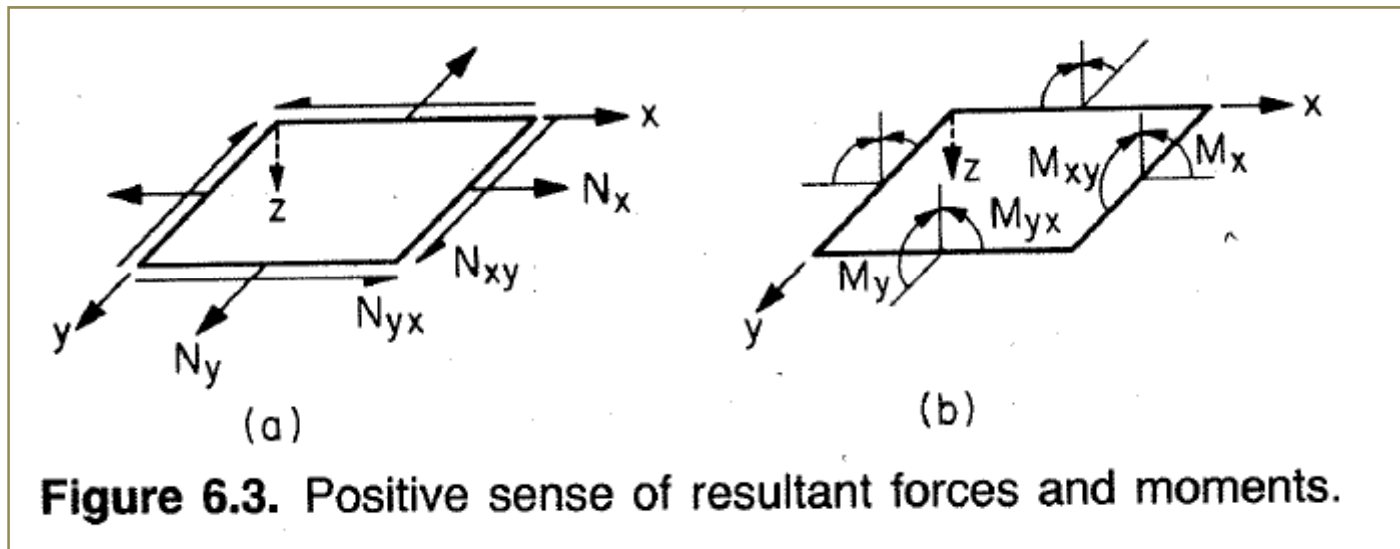

$$\begin{Bmatrix} N_x \\ N_y \\ N_{xy} \end{Bmatrix} = \int_{-h/2}^{h/2} \begin{Bmatrix} \sigma_x \\ \sigma_y \\ \tau_{xy} \end{Bmatrix} dz = \sum_{k=1}^n \int_{h_{k-1}}^{h_k} \begin{Bmatrix} \sigma_x \\ \sigma_y \\ \tau_{xy} \end{Bmatrix}_k dz$$

Sum of the contributions
of the various layers

$$\begin{Bmatrix} M_x \\ M_y \\ M_{xy} \end{Bmatrix} = \int_{-h/2}^{h/2} \begin{Bmatrix} \sigma_x \\ \sigma_y \\ \tau_{xy} \end{Bmatrix} z dz = \sum_{k=1}^n \int_{h_{k-1}}^{h_k} \begin{Bmatrix} \sigma_x \\ \sigma_y \\ \tau_{xy} \end{Bmatrix}_k z dz$$

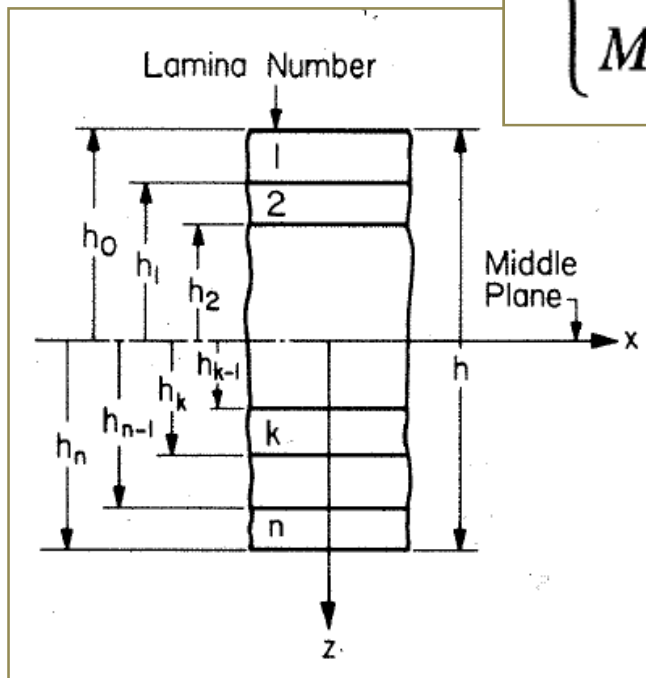

For every layer:

$$\begin{Bmatrix} \sigma_x \\ \sigma_y \\ \tau_{xy} \end{Bmatrix}_k = \begin{bmatrix} \bar{Q}_{11} & \bar{Q}_{12} & \bar{Q}_{16} \\ \bar{Q}_{12} & \bar{Q}_{22} & \bar{Q}_{26} \\ \bar{Q}_{16} & \bar{Q}_{26} & \bar{Q}_{66} \end{bmatrix}_k \begin{Bmatrix} \epsilon_x^0 \\ \epsilon_y^0 \\ \gamma_{xy}^0 \end{Bmatrix} + z \begin{bmatrix} \bar{Q}_{11} & \bar{Q}_{12} & \bar{Q}_{16} \\ \bar{Q}_{12} & \bar{Q}_{22} & \bar{Q}_{26} \\ \bar{Q}_{16} & \bar{Q}_{26} & \bar{Q}_{66} \end{bmatrix}_k \begin{Bmatrix} k_x \\ k_y \\ k_{xy} \end{Bmatrix}$$

Do not depend on z

$$\begin{Bmatrix} N_x \\ N_y \\ N_{xy} \end{Bmatrix} = \sum_{k=1}^n \left\{ \int_{h_{k-1}}^{h_k} \begin{bmatrix} \bar{Q}_{11} & \bar{Q}_{12} & \bar{Q}_{16} \\ \bar{Q}_{12} & \bar{Q}_{22} & \bar{Q}_{26} \\ \bar{Q}_{16} & \bar{Q}_{26} & \bar{Q}_{66} \end{bmatrix}_k \begin{Bmatrix} \epsilon_x^0 \\ \epsilon_y^0 \\ \gamma_{xy}^0 \end{Bmatrix} dz + \int_{h_{k-1}}^{h_k} \begin{bmatrix} \bar{Q}_{11} & \bar{Q}_{12} & \bar{Q}_{16} \\ \bar{Q}_{12} & \bar{Q}_{22} & \bar{Q}_{26} \\ \bar{Q}_{16} & \bar{Q}_{26} & \bar{Q}_{66} \end{bmatrix}_k \begin{Bmatrix} k_x \\ k_y \\ k_{xy} \end{Bmatrix} z dz \right\}$$

$$\begin{Bmatrix} M_x \\ M_y \\ M_{xy} \end{Bmatrix} = \sum_{k=1}^n \left\{ \int_{h_{k-1}}^{h_k} \begin{bmatrix} \bar{Q}_{11} & \bar{Q}_{12} & \bar{Q}_{16} \\ \bar{Q}_{12} & \bar{Q}_{22} & \bar{Q}_{26} \\ \bar{Q}_{16} & \bar{Q}_{26} & \bar{Q}_{66} \end{bmatrix}_k \begin{Bmatrix} \epsilon_x^0 \\ \epsilon_y^0 \\ \gamma_{xy}^0 \end{Bmatrix} z dz + \int_{h_{k-1}}^{h_k} \begin{bmatrix} \bar{Q}_{11} & \bar{Q}_{12} & \bar{Q}_{16} \\ \bar{Q}_{12} & \bar{Q}_{22} & \bar{Q}_{26} \\ \bar{Q}_{16} & \bar{Q}_{26} & \bar{Q}_{66} \end{bmatrix}_k \begin{Bmatrix} k_x \\ k_y \\ k_{xy} \end{Bmatrix} z^2 dz \right\}$$

$$\begin{Bmatrix} N_x \\ N_y \\ N_{xy} \end{Bmatrix} = \overset{A}{\sum_{k=1}^n \begin{bmatrix} \bar{Q}_{11} & \bar{Q}_{12} & \bar{Q}_{16} \\ \bar{Q}_{12} & \bar{Q}_{22} & \bar{Q}_{26} \\ \bar{Q}_{16} & \bar{Q}_{26} & \bar{Q}_{66} \end{bmatrix}_k \int_{h_{k-1}}^{h_k} dz} \begin{Bmatrix} \epsilon_x^0 \\ \epsilon_y^0 \\ \gamma_{xy}^0 \end{Bmatrix} + \overset{B}{\sum_{k=1}^n \begin{bmatrix} \bar{Q}_{11} & \bar{Q}_{12} & \bar{Q}_{16} \\ \bar{Q}_{12} & \bar{Q}_{22} & \bar{Q}_{26} \\ \bar{Q}_{16} & \bar{Q}_{26} & \bar{Q}_{66} \end{bmatrix}_k \int_{h_{k-1}}^{h_k} z dz} \begin{Bmatrix} k_x \\ k_y \\ k_{xy} \end{Bmatrix}$$

$$\begin{Bmatrix} M_x \\ M_y \\ M_{xy} \end{Bmatrix} = \overset{B}{\sum_{k=1}^n \begin{bmatrix} \bar{Q}_{11} & \bar{Q}_{12} & \bar{Q}_{16} \\ \bar{Q}_{12} & \bar{Q}_{22} & \bar{Q}_{26} \\ \bar{Q}_{16} & \bar{Q}_{26} & \bar{Q}_{66} \end{bmatrix}_k \int_{h_{k-1}}^{h_k} z dz} \begin{Bmatrix} \epsilon_x^0 \\ \epsilon_y^0 \\ \gamma_{xy}^0 \end{Bmatrix} + \overset{D}{\sum_{k=1}^n \begin{bmatrix} \bar{Q}_{11} & \bar{Q}_{12} & \bar{Q}_{16} \\ \bar{Q}_{12} & \bar{Q}_{22} & \bar{Q}_{26} \\ \bar{Q}_{16} & \bar{Q}_{26} & \bar{Q}_{66} \end{bmatrix}_k \int_{h_{k-1}}^{h_k} z^2 dz} \begin{Bmatrix} k_x \\ k_y \\ k_{xy} \end{Bmatrix}$$

$$\begin{Bmatrix} N \\ M \end{Bmatrix} = \begin{bmatrix} A & B \\ B & D \end{bmatrix} \begin{Bmatrix} \epsilon^0 \\ k \end{Bmatrix}$$

$$\begin{Bmatrix} N_x \\ N_y \\ N_{xy} \end{Bmatrix} = \begin{bmatrix} A_{11} & A_{12} & A_{16} \\ A_{12} & A_{22} & A_{26} \\ A_{16} & A_{26} & A_{66} \end{bmatrix} \begin{Bmatrix} \epsilon_x^0 \\ \epsilon_y^0 \\ \gamma_{xy}^0 \end{Bmatrix} + \begin{bmatrix} B_{11} & B_{12} & B_{16} \\ B_{12} & B_{22} & B_{26} \\ B_{16} & B_{26} & B_{66} \end{bmatrix} \begin{Bmatrix} k_x \\ k_y \\ k_{xy} \end{Bmatrix}$$

$$\begin{Bmatrix} M_x \\ M_y \\ M_{xy} \end{Bmatrix} = \begin{bmatrix} B_{11} & B_{12} & B_{16} \\ B_{12} & B_{22} & B_{26} \\ B_{16} & B_{26} & B_{66} \end{bmatrix} \begin{Bmatrix} \epsilon_x^0 \\ \epsilon_y^0 \\ \gamma_{xy}^0 \end{Bmatrix} + \begin{bmatrix} D_{11} & D_{12} & D_{16} \\ D_{12} & D_{22} & D_{26} \\ D_{16} & D_{26} & D_{66} \end{bmatrix} \begin{Bmatrix} k_x \\ k_y \\ k_{xy} \end{Bmatrix}$$

Extensional stiffness matrix

$$A_{ij} = \sum_{k=1}^n (\bar{Q}_{ij})_k (h_k - h_{k-1})$$

Coupling stiffness matrix
($B=0$ for symmetric stacking)

$$B_{ij} = \frac{1}{2} \sum_{k=1}^n (\bar{Q}_{ij})_k (h_k^2 - h_{k-1}^2)$$

Bending stiffness matrix

$$D_{ij} = \frac{1}{3} \sum_{k=1}^n (\bar{Q}_{ij})_k (h_k^3 - h_{k-1}^3)$$

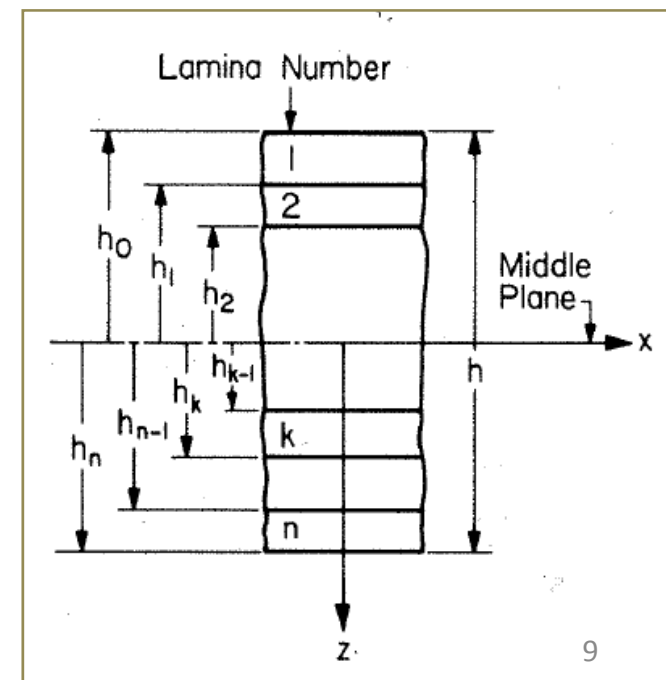

Example: Non-symmetric two-ply laminate
 (5mm at 0° and 3mm at 45°) Calculate the stiffness matrix

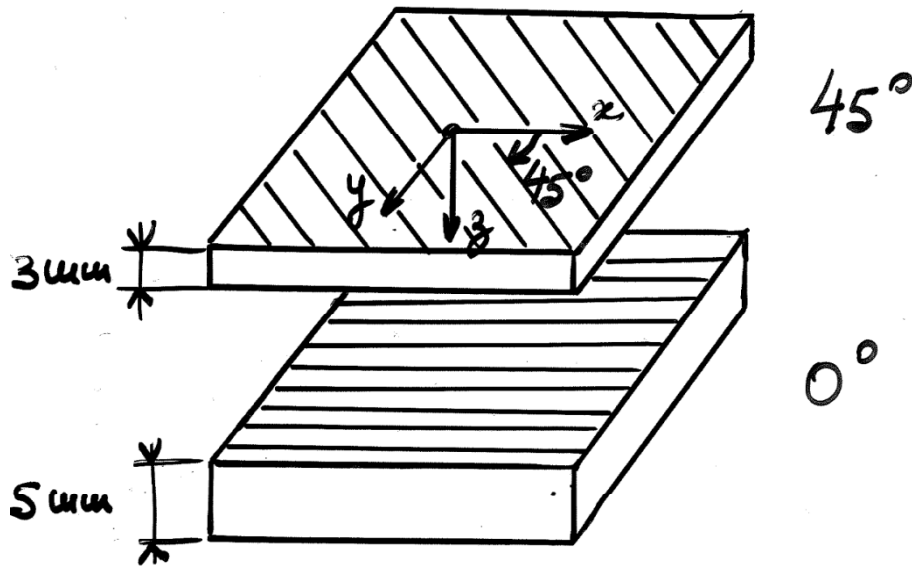

Stiffness matrix of one ply
 in principal material axes:

$$[Q] = \begin{bmatrix} 20 & 0.7 & 0 \\ 0.7 & 2.0 & 0 \\ 0 & 0 & 0.7 \end{bmatrix} \text{ GPa}$$

Step 1: Compute the stiffness matrix for the ply at 45°
 [using formula (5.61) with $\theta=45^\circ$]

$$[\bar{Q}]_{45^\circ} = \begin{bmatrix} 6.55 & 5.15 & 4.50 \\ 5.15 & 6.55 & 4.50 \\ 4.50 & 4.50 & 5.15 \end{bmatrix}$$

Stiffness matrix in arbitrary axes

$$\begin{Bmatrix} \sigma_x \\ \sigma_y \\ \tau_{xy} \end{Bmatrix} = \begin{bmatrix} \bar{Q}_{11} & \bar{Q}_{12} & \bar{Q}_{16} \\ \bar{Q}_{12} & \bar{Q}_{22} & \bar{Q}_{26} \\ \bar{Q}_{16} & \bar{Q}_{26} & \bar{Q}_{66} \end{bmatrix} \begin{Bmatrix} \epsilon_x \\ \epsilon_y \\ \gamma_{xy} \end{Bmatrix}$$

$$\begin{aligned} \bar{Q}_{11} &= Q_{11} \cos^4 \theta + Q_{22} \sin^4 \theta + 2(Q_{12} + 2Q_{66}) \sin^2 \theta \cos^2 \theta \\ \bar{Q}_{22} &= Q_{11} \sin^4 \theta + Q_{22} \cos^4 \theta + 2(Q_{12} + 2Q_{66}) \sin^2 \theta \cos^2 \theta \\ \bar{Q}_{12} &= (Q_{11} + Q_{22} - 4Q_{66}) \sin^2 \theta \cos^2 \theta + Q_{12}(\cos^4 \theta + \sin^4 \theta) \\ \bar{Q}_{66} &= (Q_{11} + Q_{22} - 2Q_{12} - 2Q_{66}) \sin^2 \theta \cos^2 \theta + Q_{66}(\sin^4 \theta + \cos^4 \theta) \\ \bar{Q}_{16} &= (Q_{11} - Q_{12} - 2Q_{66}) \cos^3 \theta \sin \theta - (Q_{22} - Q_{12} - 2Q_{66}) \cos \theta \sin^3 \theta \\ \bar{Q}_{26} &= (Q_{11} - Q_{12} - 2Q_{66}) \cos \theta \sin^3 \theta - (Q_{22} - Q_{12} - 2Q_{66}) \cos^3 \theta \sin \theta \end{aligned} \quad (5.61)$$

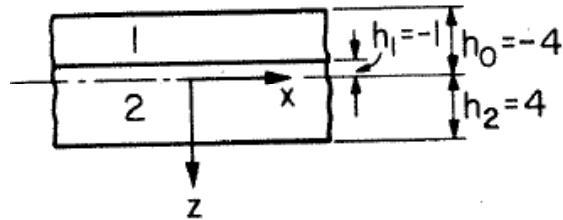
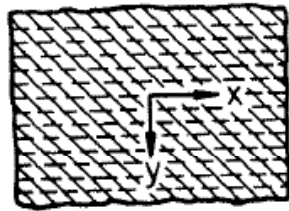

Step 2: Global stiffness matrix

$$A_{ij} = \sum_{k=1}^n (\bar{Q}_{ij})_k (h_k - h_{k-1})$$

$$= (\bar{Q}_{ij})_{45^\circ} [(-1) - (-4)] + (\bar{Q}_{ij})_{0^\circ} [4 - (-1)]$$

$$A_{ij} = 3(\bar{Q}_{ij})_{45^\circ} + 5(\bar{Q}_{ij})_{0^\circ}$$

$$B_{ij} = \frac{1}{2} \sum_{k=1}^n (\bar{Q}_{ij})_k (h_k^2 - h_{k-1}^2) = \frac{1}{2} (\bar{Q}_{ij})_{45^\circ} [(-1)^2 - (-4)^2]$$

$$+ \frac{1}{2} (\bar{Q}_{ij})_{0^\circ} [(4)^2 - (-1)^2]$$

$$= 7.5[-(\bar{Q}_{ij})_{45^\circ} + (\bar{Q}_{ij})_{0^\circ}]$$

Opposite signs !

$$D_{ij} = \frac{1}{3} \sum_{k=1}^n (\bar{Q}_{ij})_k (h_k^3 - h_{k-1}^3) = \frac{1}{3} (\bar{Q}_{ij})_{45^\circ} [(-1)^3 - (-4)^3]$$

$$+ \frac{1}{3} (\bar{Q}_{ij})_{0^\circ} [(4)^3 - (-1)^3]$$

$$= 21(\bar{Q}_{ij})_{45^\circ} + 21.67(\bar{Q}_{ij})_{0^\circ}$$

$$[A] = \begin{bmatrix} 119.65 & 18.95 & 13.50 \\ 18.95 & 29.65 & 13.50 \\ 13.50 & 13.50 & 18.95 \end{bmatrix}$$

$$[B] = \begin{bmatrix} 100.9 & -33.4 & -33.75 \\ -33.4 & -34.1 & -33.75 \\ -33.75 & -33.75 & -33.40 \end{bmatrix}$$

$$[D] = \begin{bmatrix} 571 & 123 & 94.5 \\ 123 & 181 & 94.5 \\ 94.5 & 94.5 & 123 \end{bmatrix}$$

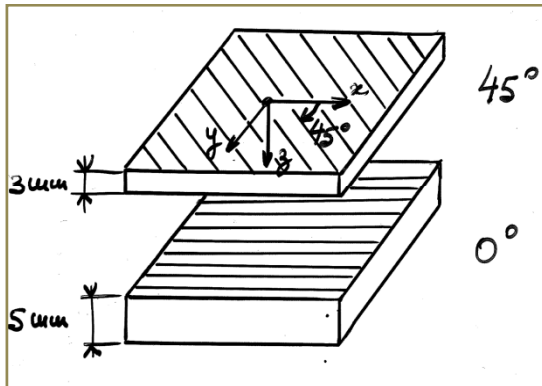

Constitutive equation for the two-ply laminate

$$\begin{Bmatrix} N_x \\ N_y \\ N_{xy} \\ \hline M_x \\ M_y \\ M_{xy} \end{Bmatrix} = \begin{bmatrix} 119.6 & 18.9 & 13.5 & | & 100.9 & -33.4 & -33.8 \\ 18.9 & 29.6 & 13.5 & | & -33.4 & -34.1 & -33.8 \\ 13.5 & 13.5 & 18.9 & | & -33.8 & -33.8 & -33.4 \\ \hline 100.9 & -33.4 & -33.8 & | & 571 & 123 & 94.5 \\ -33.4 & -34.1 & -33.8 & | & 123 & 181 & 94.5 \\ -33.8 & -33.8 & -33.4 & | & 94.5 & 94.5 & 123 \end{bmatrix} \begin{Bmatrix} \epsilon_x^0 \\ \epsilon_y^0 \\ \gamma_{xy}^0 \\ \hline k_x \\ k_y \\ k_{xy} \end{Bmatrix}$$

Symmetric laminate

$$[\bar{Q}]_i = [\bar{Q}]_{k+1}$$

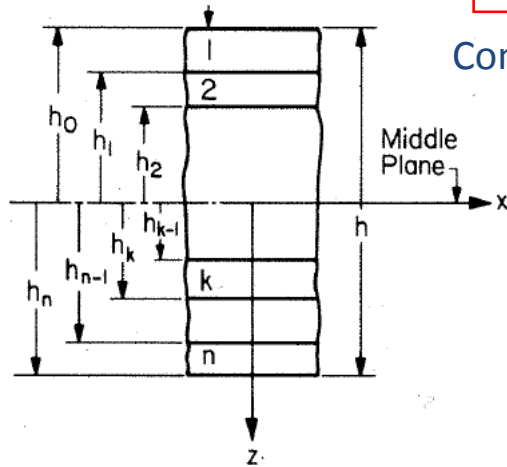

Contribution to B of symmetric layers:

$$\longrightarrow [\bar{Q}]_i (h_i^2 - h_{i-1}^2)$$

$$\longrightarrow [\bar{Q}]_{k+1} (h_{k+1}^2 - h_k^2)$$

$$\Sigma = 0 \longrightarrow B = 0$$

No coupling between in-plane forces and out of plane deformations (very important for thermal stability!)

Orthotropic in the plane

$$A_{16} = A_{26} = 0$$

$$\begin{Bmatrix} N_x \\ N_y \\ N_{xy} \end{Bmatrix} = \begin{bmatrix} A_{11} & A_{12} & A_{16} \\ A_{12} & A_{22} & A_{26} \\ A_{16} & A_{26} & A_{66} \end{bmatrix} \begin{Bmatrix} \epsilon_x^0 \\ \epsilon_y^0 \\ \gamma_{xy}^0 \end{Bmatrix} + \begin{bmatrix} B_{11} & B_{12} & B_{16} \\ B_{12} & B_{22} & B_{26} \\ B_{16} & B_{26} & B_{66} \end{bmatrix} \begin{Bmatrix} k_x \\ k_y \\ k_{xy} \end{Bmatrix}$$

$$A_{16} = \sum_k [Q_{16}]_k (h_k - h_{k-1})$$

thickness

Odd function of θ

For every ply with $+\theta$, there should be another ply with the same thickness oriented at $-\theta$

Example: Four-ply laminate $[\pm 45^\circ]_S$

Each ply has a thickness of 3 mm

$$[\bar{Q}]_1 = [\bar{Q}]_4 = \begin{bmatrix} 6.55 & 5.15 & 4.50 \\ 5.15 & 6.55 & 4.50 \\ 4.50 & 4.50 & 5.15 \end{bmatrix}$$

$$[\bar{Q}]_2 = [\bar{Q}]_3 = \begin{bmatrix} 6.55 & 5.15 & -4.50 \\ 5.15 & 6.55 & -4.50 \\ -4.50 & -4.50 & 5.15 \end{bmatrix}$$

$$A_{ij} = 3[(\bar{Q}_{ij})_1 + (\bar{Q}_{ij})_2 + (\bar{Q}_{ij})_3 + (\bar{Q}_{ij})_4] \\ = 6[(\bar{Q}_{ij})_1 + (\bar{Q}_{ij})_2]$$

Because of symmetry: $B_{ij} = 0.$

$$D_{ij} = \frac{1}{3} \{ (\bar{Q}_{ij})_1 [(-3)^3 - (-6)^3] + (\bar{Q}_{ij})_2 [(0)^3 - (-3)^3] \\ + (\bar{Q}_{ij})_3 [(3)^3 - (0)^3] + (\bar{Q}_{ij})_4 [(6)^3 - (3)^3] \} \\ = 126(\bar{Q}_{ij})_1 + 18(\bar{Q}_{ij})_2$$

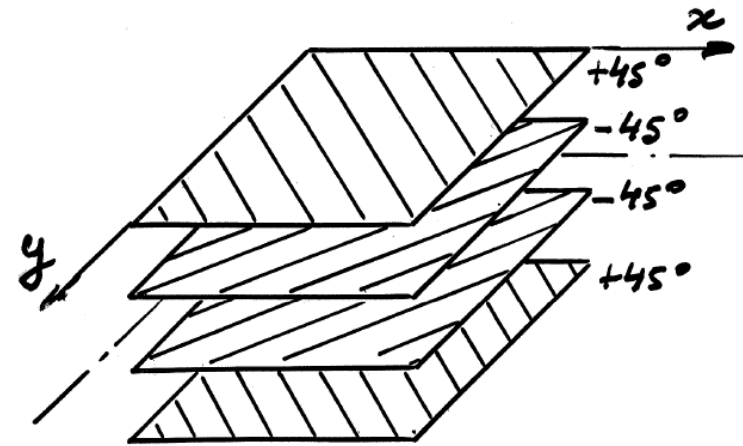

$$A = \begin{bmatrix} 78.6 & 61.8 & 0 \\ 61.8 & 78.6 & 0 \\ 0 & 0 & 61.8 \end{bmatrix}$$

orthotropic

$$D = \begin{bmatrix} 943.2 & 741.6 & 486.0 \\ 741.6 & 943.2 & 486.0 \\ 486.0 & 486.0 & 741.6 \end{bmatrix}$$

Coupling
Bending-torsion

How to minimize the coupling between bending and torsion ?

$$\begin{Bmatrix} M_x \\ M_y \\ M_{xy} \end{Bmatrix} = \begin{bmatrix} B_{11} & B_{12} & B_{16} \\ B_{12} & B_{22} & B_{26} \\ B_{16} & B_{26} & B_{66} \end{bmatrix} \begin{Bmatrix} \epsilon_x^0 \\ \epsilon_y^0 \\ \gamma_{xy}^0 \end{Bmatrix} + \begin{bmatrix} D_{11} & D_{12} & D_{16} \\ D_{12} & D_{22} & D_{26} \\ D_{16} & D_{26} & D_{66} \end{bmatrix} \begin{Bmatrix} k_x \\ k_y \\ k_{xy} \end{Bmatrix}$$

$$D_{ij} = \frac{1}{3} \sum_{k=1}^n (\bar{Q}_{ij})_k (h_k^3 - h_{k-1}^3)$$

Q_{16} and Q_{26} are odd functions of θ

$$\bar{Q}_{16} = (Q_{11} - Q_{12} - 2Q_{66}) \cos^3 \theta \sin \theta - (Q_{22} - Q_{12} - 2Q_{66}) \cos \theta \sin^3 \theta$$

$$\bar{Q}_{26} = (Q_{11} - Q_{12} - 2Q_{66}) \cos \theta \sin^3 \theta - (Q_{22} - Q_{12} - 2Q_{66}) \cos^3 \theta \sin \theta$$

Option 1: All layers oriented at 0° or 90°

Option 2: For every layer at $+\theta$ above the mid-plane, there should be a layer with the same thickness and oriented at $-\theta$, at the same distance below the midplane.

But this is incompatible with symmetry !

For a symmetric laminate, D_{16} and D_{26} cannot be zero. However, by stacking the layers alternatively at $+\theta$ and $-\theta$, D_{16} and D_{26} can be minimized, especially if the number of layers is large.

45°  -45° 

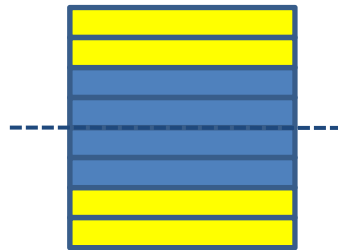

$[(45)_2/(-45)_2]_S$

$$[D] = 10^3 \begin{bmatrix} 7.55 & 5.93 & 3.89 \\ 5.93 & 7.55 & 3.89 \\ 3.89 & 3.89 & 5.93 \end{bmatrix}$$

$$\frac{D_{16}}{D_{11}} = 0.515$$

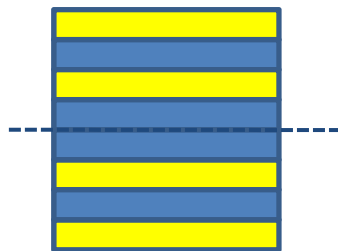

$[(\pm 45)_2]_S$

$$[D] = 10^3 \times \begin{bmatrix} 7.55 & 5.93 & 1.94 \\ 5.93 & 7.55 & 1.94 \\ 1.94 & 1.94 & 5.93 \end{bmatrix}$$

$$\frac{D_{16}}{D_{11}} = 0.257$$

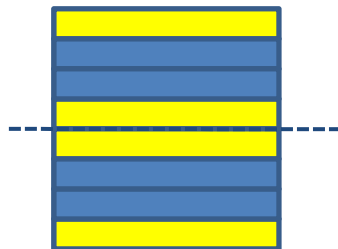

$[\pm \mp 45]_S$

$$[D] = 10^3 \begin{bmatrix} 7.55 & 5.93 & 0.97 \\ 5.93 & 7.55 & 0.97 \\ 0.97 & 0.97 & 5.93 \end{bmatrix}$$

unchanged

$$\frac{D_{16}}{D_{11}} = 0.129$$

Quasi-isotropic laminate

Constitutive equations of an isotropic material:

$$\begin{pmatrix} \sigma_x \\ \sigma_y \\ \tau_{xy} \end{pmatrix} = \begin{bmatrix} \frac{E}{1-\nu^2} & \frac{\nu E}{1-\nu^2} & 0 \\ \frac{\nu E}{1-\nu^2} & \frac{E}{1-\nu^2} & 0 \\ 0 & 0 & G \end{bmatrix} \begin{pmatrix} \varepsilon_x \\ \varepsilon_y \\ \gamma_{xy} \end{pmatrix}$$

$$\begin{aligned} Q_{11} &= Q_{22} \\ Q_{16} &= Q_{26} = 0 \\ Q_{11} - Q_{12} &= 2Q_{66} \end{aligned}$$

A **quasi-isotropic laminate** has the extensional stiffness properties of an isotropic material:

Construction:

- The total number n of layers must be 3 or more
- Identical individual layers (Q and t)
- The layers must be oriented at equal angles:
 π/n between two layers

Examples:

$$[0/\pm 60]$$

$$[0/\pm 45/90]$$

$$\begin{aligned} A_{11} &= A_{22} \\ A_{16} &= A_{26} = 0 \\ A_{11} - A_{12} &= 2A_{66} \end{aligned}$$

Also: $[+45/-45/0/90]_S$ $[0/60/-60]_S$

But not: $[0/90]_S$ $[+45/-45]_S$

Stresses and strains in the layers

Step 1: Invert the stiffness matrix to compute the mid plane strains and the curvatures:

$$\begin{Bmatrix} N \\ M \end{Bmatrix} = \begin{bmatrix} A & B \\ B & D \end{bmatrix} \begin{Bmatrix} \epsilon^0 \\ k \end{Bmatrix} \Rightarrow \begin{Bmatrix} \epsilon^0 \\ k \end{Bmatrix} = \begin{bmatrix} A' & B' \\ B' & D' \end{bmatrix} \begin{Bmatrix} N \\ M \end{Bmatrix}$$

Step 2: for every layer, one compute the stresses in global coordinates (x,y):

$$\begin{Bmatrix} \sigma_x \\ \sigma_y \\ \tau_{xy} \end{Bmatrix}_k = \begin{bmatrix} \bar{Q}_{11} & \bar{Q}_{12} & \bar{Q}_{16} \\ \bar{Q}_{12} & \bar{Q}_{22} & \bar{Q}_{26} \\ \bar{Q}_{16} & \bar{Q}_{26} & \bar{Q}_{66} \end{bmatrix}_k \left[\begin{Bmatrix} \epsilon_x^0 \\ \epsilon_y^0 \\ \gamma_{xy}^0 \end{Bmatrix} + z \begin{Bmatrix} k_x \\ k_y \\ k_{xy} \end{Bmatrix} \right] \quad \text{(linear over the thickness of the layer)}$$

Step 3: before applying the failure criteria, one must transform the stresses in the (L,T) frame

Example: three-ply laminate $[45^\circ/0]_s$

$$[\bar{Q}]_2 = \begin{bmatrix} 20 & 0.7 & 0 \\ 0.7 & 2.0 & 0 \\ 0 & 0 & 0.7 \end{bmatrix} \quad [\bar{Q}]_1 = [\bar{Q}]_3 = \begin{bmatrix} 6.55 & 5.15 & 4.50 \\ 5.15 & 6.55 & 4.50 \\ 4.50 & 4.50 & 5.15 \end{bmatrix}$$

$$A_{ij} = \sum_{k=1} (\bar{Q}_{ij})_k (h_k - h_{k-1})$$

$$[A] = \begin{bmatrix} 159.3 & 35.1 & 27.0 \\ 35.1 & 51.3 & 27.0 \\ 27.0 & 27.0 & 35.1 \end{bmatrix}$$

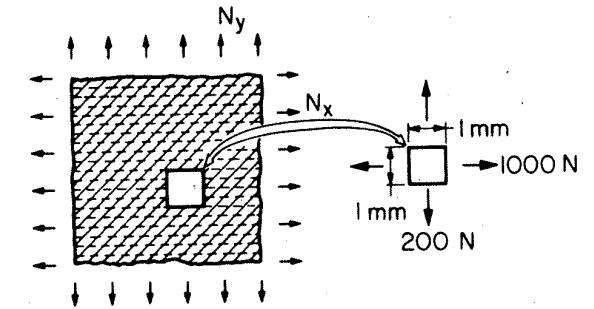
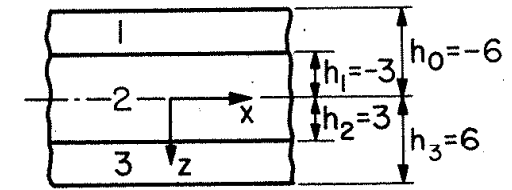

In-plane forces:

$$N_x = 1000 \text{ N/mm} \quad N_y = 200 \text{ N/mm} \quad N_{xy} = 0$$

$$\begin{Bmatrix} \epsilon_x^0 \\ \epsilon_y^0 \\ \gamma_{xy}^0 \end{Bmatrix} = 10^{-3} \begin{bmatrix} 0.00759 & -0.00356 & -0.00309 \\ -0.00356 & 0.03441 & -0.02373 \\ -0.00309 & -0.02373 & 0.04911 \end{bmatrix} \begin{Bmatrix} 1000 \\ 200 \\ 0 \end{Bmatrix} = \begin{Bmatrix} 0.00685 \\ 0.00332 \\ -0.00784 \end{Bmatrix}$$

The strains are identical for all layers

$$\begin{Bmatrix} \sigma_x \\ \sigma_y \\ \tau_{xy} \end{Bmatrix}_{0^\circ \text{ ply}} = \begin{bmatrix} 20 & 0.7 & 0 \\ 0.7 & 2.0 & 0 \\ 0 & 0 & 0.7 \end{bmatrix} \begin{Bmatrix} 0.00685 \\ 0.00332 \\ -0.00784 \end{Bmatrix} = \begin{Bmatrix} 139.3 \\ 11.4 \\ -5.5 \end{Bmatrix} 10^{-3} \text{ GPa}$$

$$\begin{Bmatrix} \sigma_x \\ \sigma_y \\ \tau_{xy} \end{Bmatrix}_{45^\circ \text{ ply}} = \begin{bmatrix} 6.55 & 5.15 & 4.50 \\ 5.15 & 6.55 & 4.50 \\ 4.50 & 4.50 & 5.15 \end{bmatrix} \begin{Bmatrix} 0.00685 \\ 0.00332 \\ -0.00784 \end{Bmatrix} = \begin{Bmatrix} 26.7 \\ 21.7 \\ 5.4 \end{Bmatrix} 10^{-3} \text{ GPa}$$

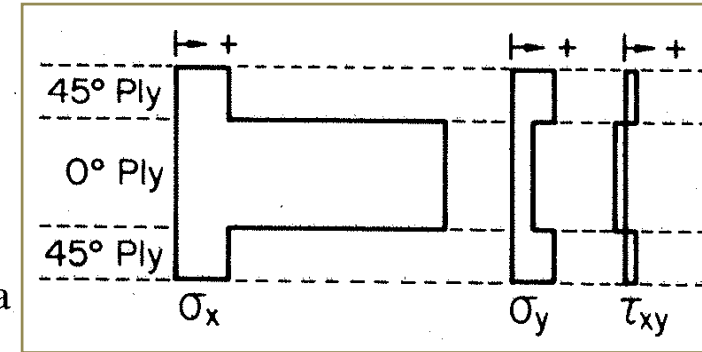

Before applying a failure test, one needs to transform into the (L,T) frame

$$\begin{Bmatrix} \sigma_L \\ \sigma_T \\ \tau_{LT} \end{Bmatrix} = [T] \begin{Bmatrix} \sigma_x \\ \sigma_y \\ \tau_{xy} \end{Bmatrix} \quad [T] = \begin{bmatrix} \cos^2 \theta & \sin^2 \theta & 2 \sin \theta \cos \theta \\ \sin^2 \theta & \cos^2 \theta & -2 \sin \theta \cos \theta \\ -\sin \theta \cos \theta & \sin \theta \cos \theta & \cos^2 \theta - \sin^2 \theta \end{bmatrix}$$

$$\begin{Bmatrix} \epsilon_L \\ \epsilon_T \\ \frac{1}{2} \gamma_{LT} \end{Bmatrix} = [T] \begin{Bmatrix} \epsilon_x \\ \epsilon_y \\ \frac{1}{2} \gamma_{xy} \end{Bmatrix} \quad T(45^\circ) = \begin{bmatrix} 0.5 & 0.5 & 1.0 \\ 0.5 & 0.5 & -1.0 \\ -0.5 & 0.5 & 0 \end{bmatrix}$$

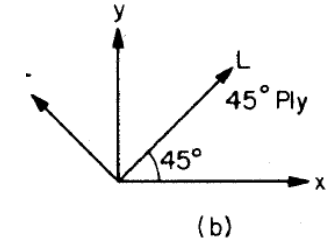

$$\begin{Bmatrix} \sigma_L \\ \sigma_T \\ \tau_{LT} \end{Bmatrix} = \begin{bmatrix} 0.5 & 0.5 & 1.0 \\ 0.5 & 0.5 & -1.0 \\ -0.5 & 0.5 & 0 \end{bmatrix} \begin{Bmatrix} 26.7 \\ 21.7 \\ 5.4 \end{Bmatrix} = \begin{Bmatrix} 29.6 \\ 18.8 \\ -2.5 \end{Bmatrix} \text{ MPa}$$

$$\begin{Bmatrix} \epsilon_L \\ \epsilon_T \\ \frac{1}{2} \gamma_{LT} \end{Bmatrix}_{45^\circ \text{ ply}} = \begin{bmatrix} 0.5 & 0.5 & 1.0 \\ 0.5 & 0.5 & -1.0 \\ -0.5 & 0.5 & 0 \end{bmatrix} \begin{Bmatrix} 0.00685 \\ 0.00332 \\ -0.00392 \end{Bmatrix} = \begin{Bmatrix} 0.00116 \\ 0.00900 \\ -0.00176 \end{Bmatrix} \Rightarrow \begin{Bmatrix} \epsilon_L \\ \epsilon_T \\ \gamma_{LT} \end{Bmatrix}_{45^\circ \text{ ply}} = \begin{Bmatrix} 0.00116 \\ 0.00900 \\ -0.00352 \end{Bmatrix}$$

Stresses and strains in (x,y) frame

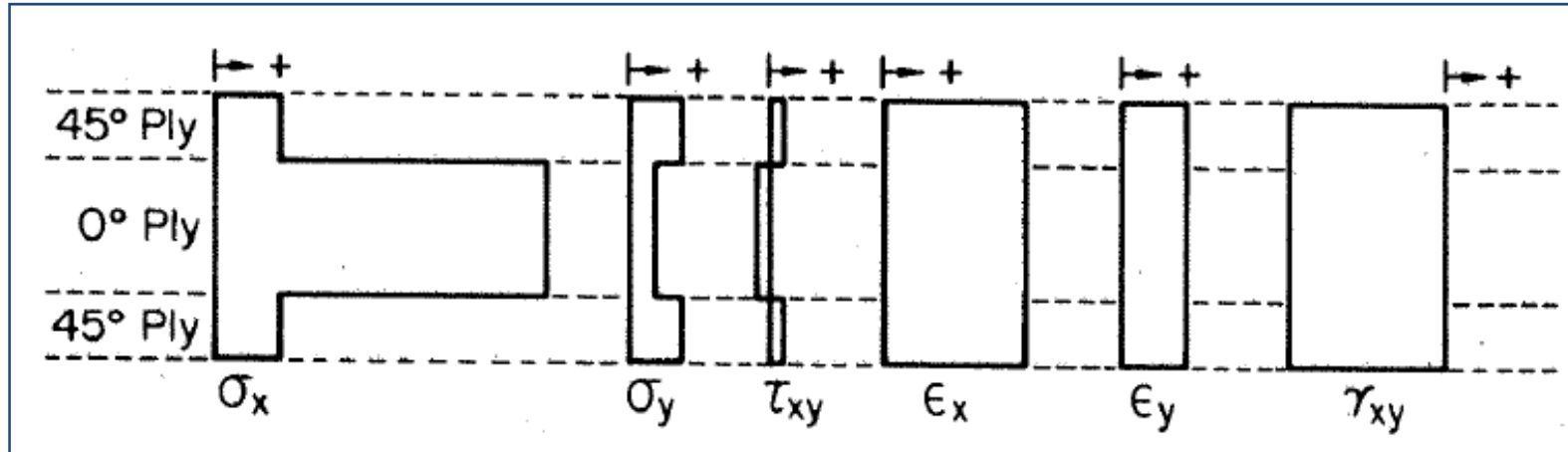

Stresses and strains in (L,T) frame

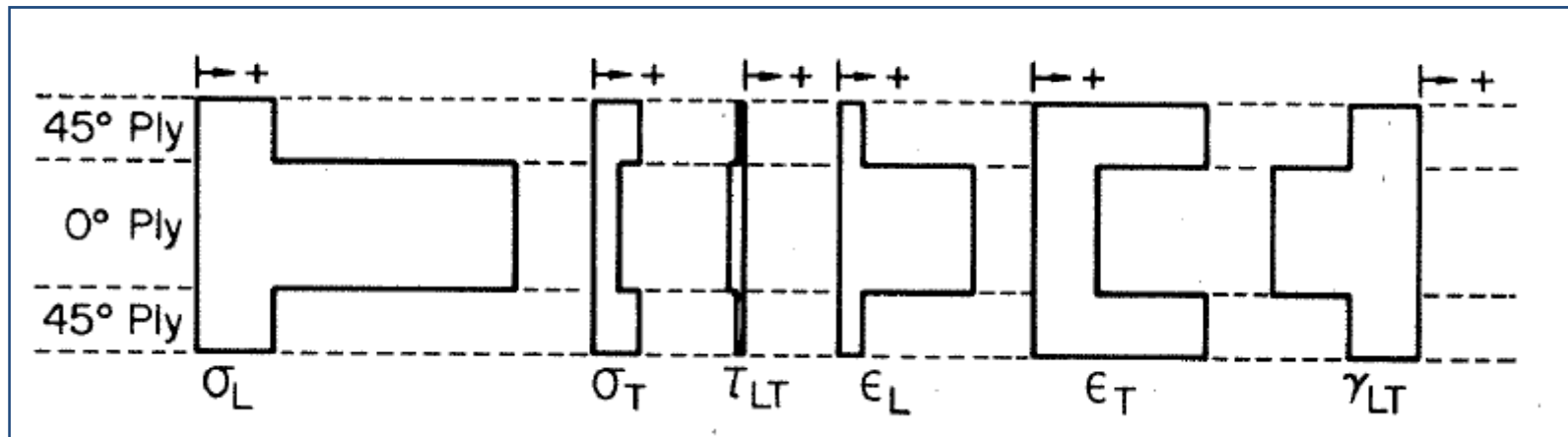

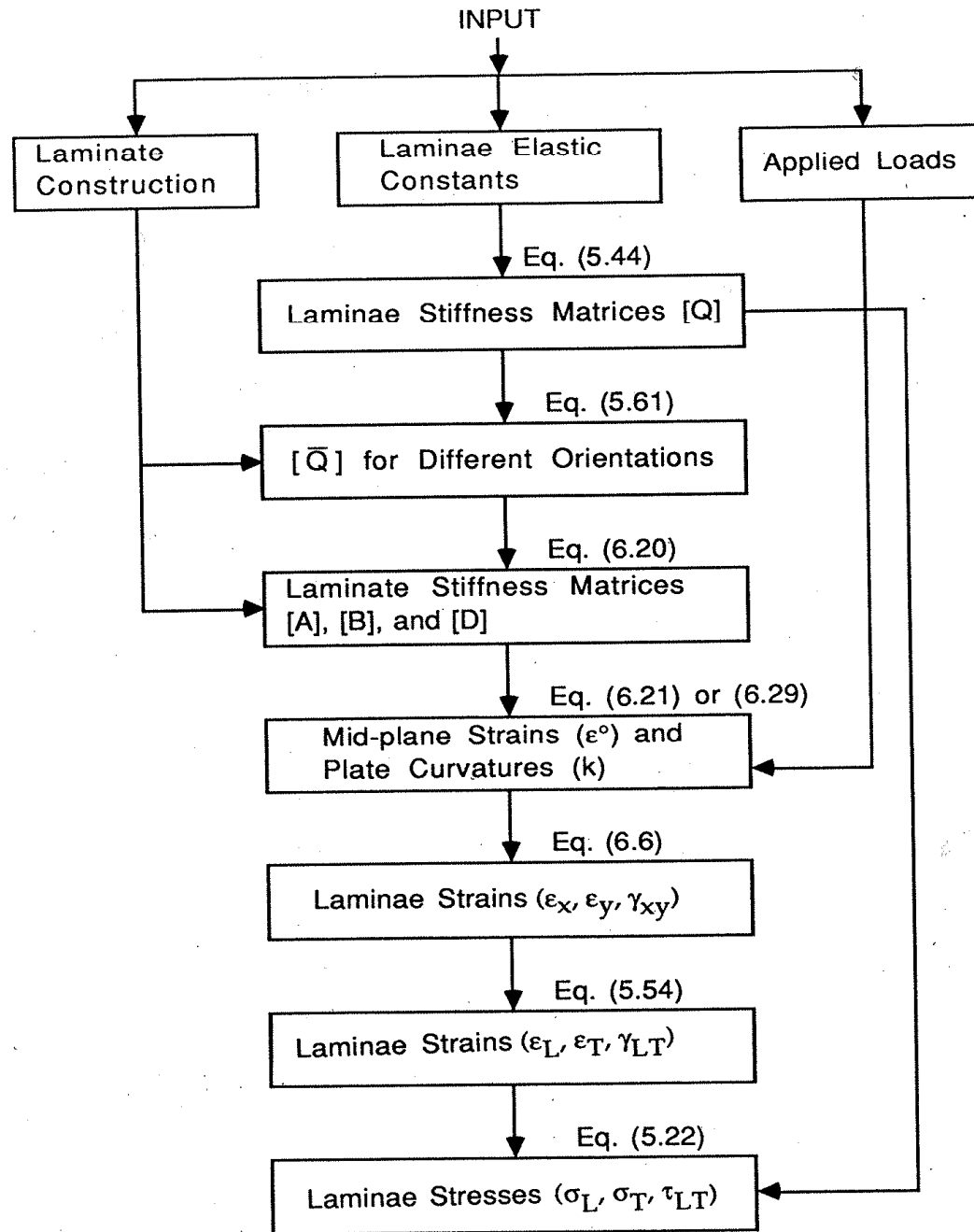

Figure 6.17. Flowchart for laminate stress analysis.